

**SVA-S/L, SVA-ST/LT, SVA-HS, size 80**

Overhaul kit | Code number 148B6155

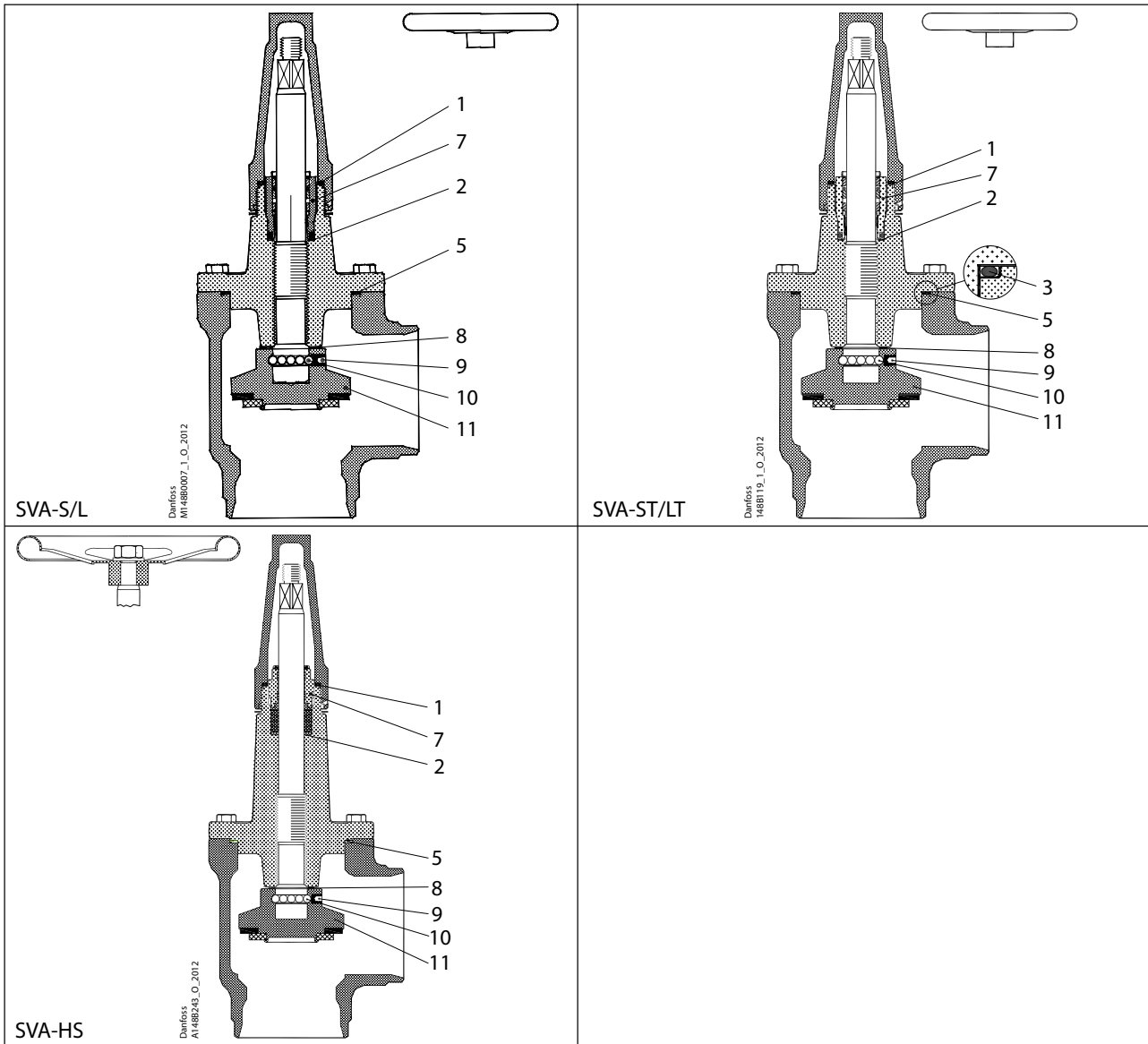

<p><b>1</b></p> <p> = Nylon</p> <p>Total no. = 1</p>	<p><b>2</b></p> <p> = Alu.</p> <p>Total no. = 1</p>	<p><b>3</b></p> <p>Total no. = 1</p>	<p><b>5</b></p> <p> = Fibre</p> <p>Total no. = 1</p>	<p><b>7</b></p> <p>Total no. = 1</p>
<p><b>8</b></p> <p> = PTFE</p> <p>Total no. = 1</p>	<p><b>9</b></p> <p>Total no. = 1</p>	<p><b>10</b></p> <p>Total no. = 13</p>	<p><b>11</b></p> <p>Total no. = 1</p>	<p><b>12</b></p> <p>Total no. = 1</p>

**NOTE:**

When replacing the packing gland (pos. 7) in SVA-S/L, SVA-ST/LT or SVA-HS the aluminium gasket (pos. 2) is needed.