

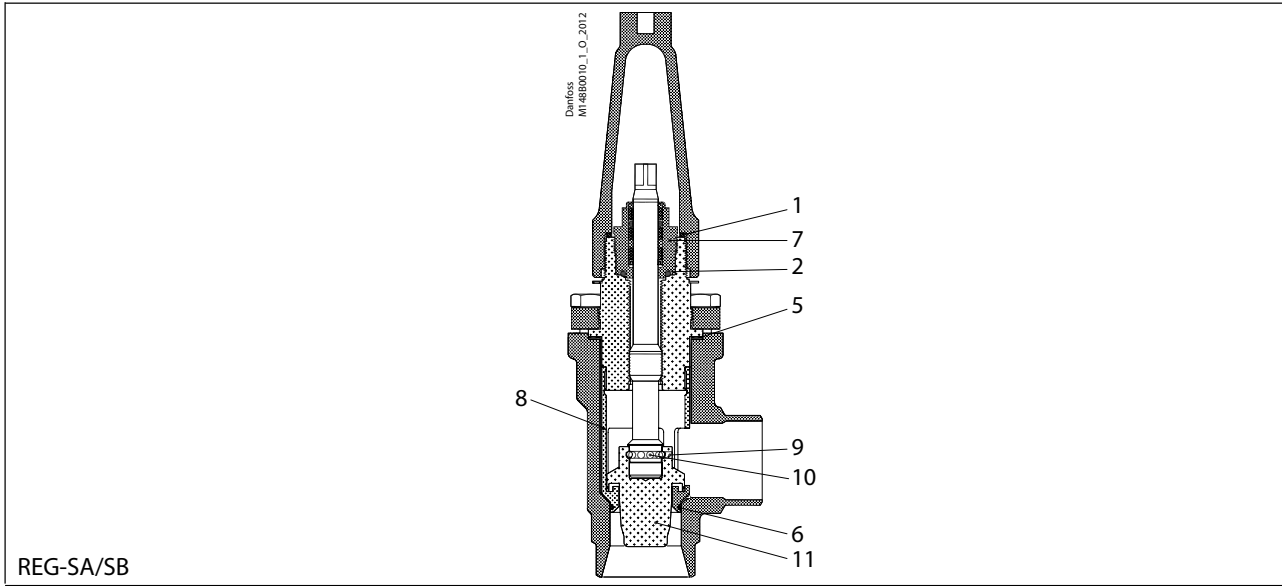

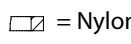

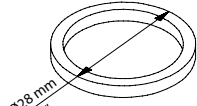
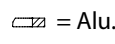
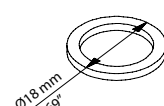

### REG-SA/SB size 15-20

Overhaul kit | Code number 148B6175

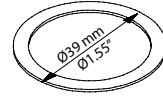

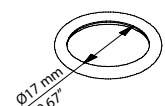
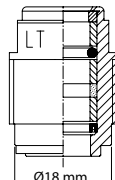
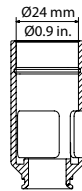
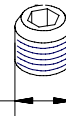
REG-SA/SB

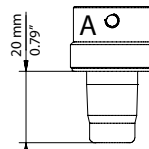
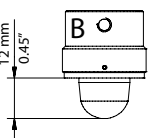
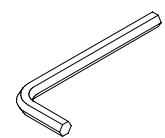
<p><b>1</b></p> <p> = Nylon</p>  <p>Total no. = 1</p>	<p><b>2</b></p> <p> = Alu.</p>  <p>Total no. = 1</p>	<p><b>5</b></p> <p> = Fibre</p>  <p>Total no. = 1</p>	<p><b>6</b></p>   <p>Total no. = 1</p>	<p><b>7</b></p>  <p>Ø18 mm Ø0.71\" data-bbox="750 490 820 505"/&gt; <p>Total no. = 1</p> </p>
<p><b>8</b></p>  <p>Total no. = 1</p>	<p><b>9</b></p>  <p>M4</p> <p>Total no. = 1</p>	<p><b>10</b></p>  <p>Ø3 mm Ø0.118\" data-bbox="420 575 500 615"/&gt; <p>Total no. = 10</p> </p>	<p><b>11</b></p>  <p>20 mm 0.79\" data-bbox="580 550 600 615"/&gt; <p>Total no. = 1</p> </p>	<p><b>11</b></p>  <p>12 mm 0.45\" data-bbox="730 555 750 615"/&gt; <p>Total no. = 1</p> </p>
<p><b>12</b></p>  <p>Total no. = 1</p>				

**NOTE:**

When replacing the packing gland (pos. 7) in REG-SA/B or REG the aluminium gasket (pos. 2) is needed.