

PML, size 80

Overhaul kit | Code number 027F0560

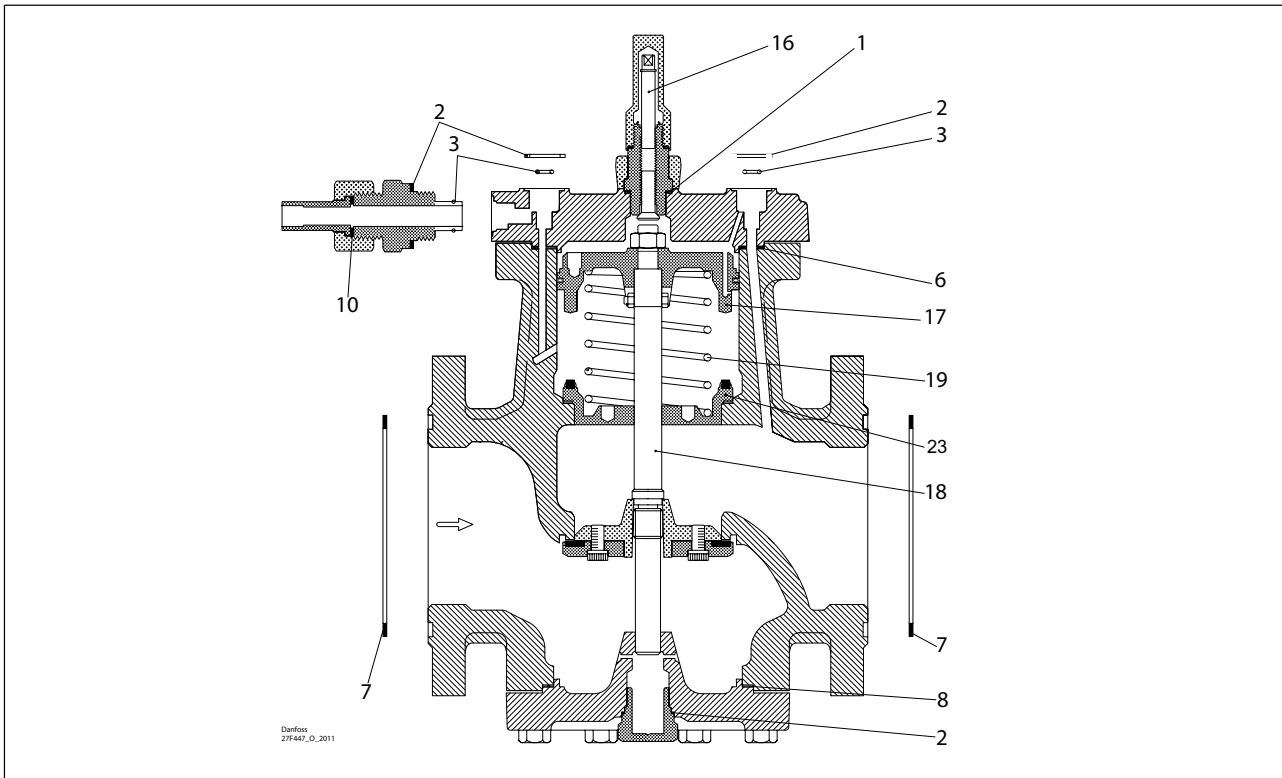

<p>1</p> <p> = Alu.</p> <p>Total no. = 1</p>	<p>2</p> <p> = Fibre</p> <p>Total no. = 4</p>	<p>3</p> <p>Total no. = 3</p>	<p>4*</p> <p> = Alu.</p> <p>Total no. = 1</p>	<p>5*</p> <p> = Alu.</p> <p>Total no. = 1</p>	<p>6</p> <p> = Fibre</p> <p>Total no. = 1</p>
<p>7</p> <p> = Fibre</p> <p>Total no. = 2</p>	<p>8</p> <p> = Fibre</p> <p>Total no. = 1</p>	<p>9*</p> <p> = Alu.</p> <p>Total no. = 1</p>	<p>10</p> <p> = Alu.</p> <p>Total no. = 1</p>	<p>16</p>	<p>17</p>
<p>18</p>	<p>19</p> <p>Total no. = 1</p>	<p>23</p>			

* The spare part is included in the package but is not used for PML size 80.