

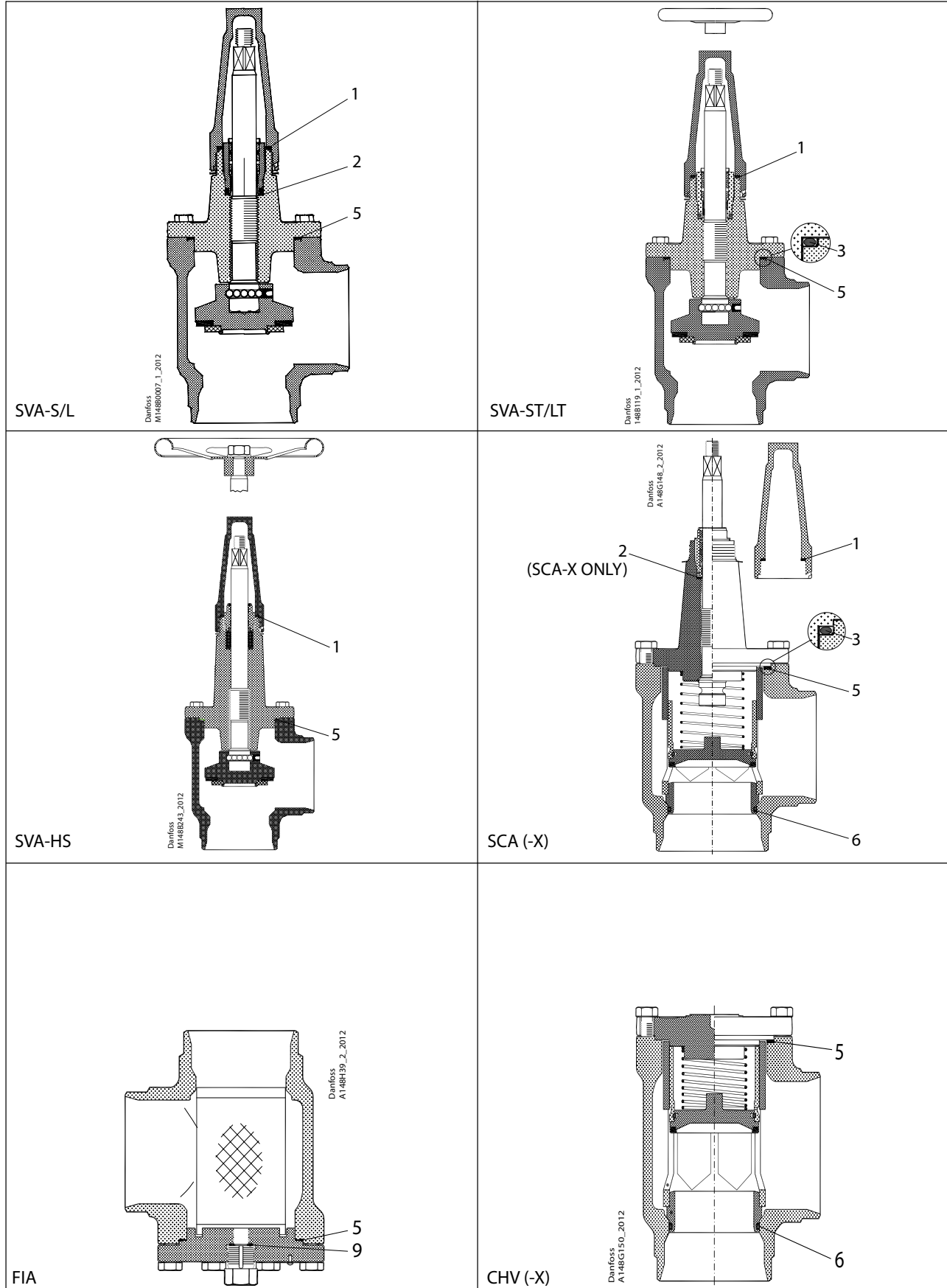









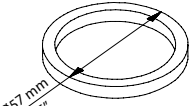

SVA-S/L, SVA-ST/LT, SVA-HS, SCA/X, FIA, CHV/X size 125

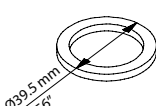
Inspection kit | Code number 148B6057

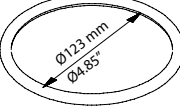

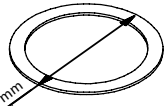
SVA-S/L, SVA-ST/LT, SVA-HS, SCA/X, FIA, CHV/X size 125

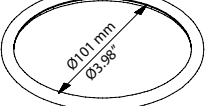
Inspection kit | Code number 148B6057

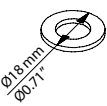
<p>1</p> <p> = Nylon</p>  <p>Total no. = 1</p>	<p>2</p> <p> = Alu.</p>  <p>Total no. = 1</p>	<p>3</p>   <p>Total no. = 1</p>	<p>5</p> <p> = Fibre</p>  <p>Total no. = 1</p>	<p>6</p>   <p>Total no. = 1</p>
<p>9</p> <p> = Alu.</p>  <p>Total no. = 1</p>				